

studio one

SETUP GUIDE



YOURS IS HERE

studio one

SETUP GUIDE

Model MTF

Notes, Cautions, and Warnings

 **NOTE:** A NOTE indicates important information that helps you make better use of your computer.

 **CAUTION:** A CAUTION indicates either potential damage to hardware or loss of data and tells you how to avoid the problem.

 **WARNING:** A WARNING indicates a potential for property damage, personal injury, or death.

Information in this document is subject to change without notice.

© 2009 Dell Inc. All rights reserved.

Reproduction of these materials in any manner whatsoever without the written permission of Dell Inc. is strictly forbidden.

Trademarks used in this text: *Dell*, the *DELL* logo, and *YOURS IS HERE* are trademarks of Dell Inc.; *Intel* and *Celeron* are registered trademarks and *Core* is a trademark of Intel Corporation in the United States and other countries; *Microsoft*, *Windows*, *Windows Vista*, and *Windows Vista* start button logo are either trademarks or registered trademarks of Microsoft Corporation in the United States and/or other countries; *Blu-ray Disc* is a trademark of the Blu-ray Disc Association; *Bluetooth* is a registered trademark owned by Bluetooth SIG, Inc. and is used by Dell under license.

Other trademarks and trade names may be used in this document to refer to either the entities claiming the marks and names or their products. Dell Inc. disclaims any proprietary interest in trademarks and trade names other than its own.

September 2009

P/N P687X

Rev. A01

Contents

Setting Up Your Studio One	5	Using the Touch Screen (Optional)	18
Before Setting Up Your Computer	5	Software Features	21
Connect the Network Cable (Optional)	6	Solving Problems	23
Connect the Power Cable	7	Touch Screen Problems	23
Set Up the Wireless Keyboard and Mouse (Optional)	7	Wireless Keyboard or Mouse Problems	24
Press the Power Button	8	Network Problems	25
Windows Vista® Setup	9	Power Problems	26
Connect to the Internet (Optional)	9	Memory Problems	27
Using Your Studio One	12	Lockups and Software Problems	27
Front View Features	12	Using Support Tools	30
Left Side Features	14	Dell Support Center	30
Back Panel Features	16	Beep Codes	30
Locating the Service Tag	17	System Messages	31
Using the Optical Disc Drive	17		

Contents

Hardware Troubleshooter	32	Finding More Information and Resources	46
Dell Diagnostics	33	Specifications	48
System Recovery Options	35	Appendix	53
System Restore	35	Macrovision Product Notice	53
Dell Factory Image Restore	36	Index	54
Operating System Reinstallation	38		
Getting Help	40		
Technical Support and Customer Service	41		
DellConnect	41		
Online Services	41		
Automated Order-Status Service	42		
Returning Items for Repair Under Warranty or for Credit	42		
Before You Call	43		
Contacting Dell	44		

Setting Up Your Studio One

This section provides information about setting up your Studio One and connecting peripherals.



WARNING: Before you begin any of the procedures in this section, read the safety information that shipped with your computer. For additional safety best practices information, see the Regulatory Compliance Homepage at www.dell.com/regulatory_compliance.

Before Setting Up Your Computer

When positioning your computer, ensure that you allow easy access to a power source, controls and connections on the left side, adequate ventilation, and a stable level surface to place your computer.

Restricting airflow around your Studio One may cause it to overheat. To prevent overheating ensure that you leave a minimum of 5.1 cm (2 inches) on all the sides. You should never place your computer in an enclosed space, such as a cabinet when it is powered on.

Connect the Network Cable (Optional)

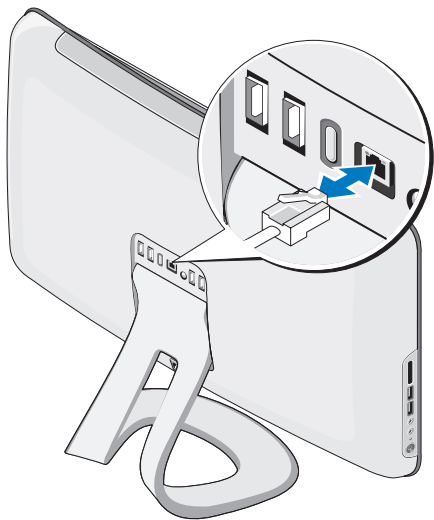

A network connection is not required to complete this computer setup, but if you have an existing network or Internet connection that uses a cable connection (such as a home cable modem or Ethernet jack), you can connect it now.

Use only an Ethernet cable (RJ45 connector). Do not plug a telephone cable (RJ11 connector) into the network connector.

To attach your computer to a network or broadband device, connect one end of a network cable to either a network port or a broadband device. Connect the other end of the network cable to the network adapter connector on the back panel of your computer. A click indicates that the network cable has been securely attached.

Connect the Power Cable

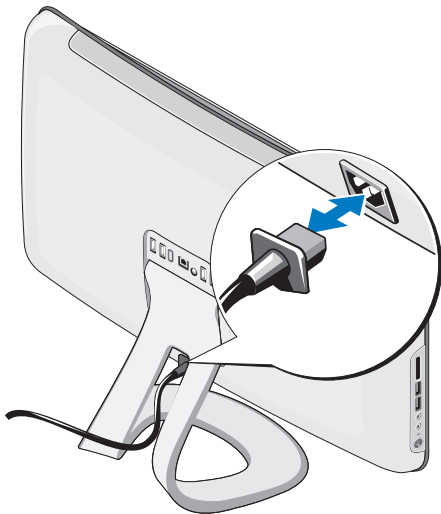

Set Up the Wireless Keyboard and Mouse (Optional)

Your Studio One supports a special wireless (non-Bluetooth) keyboard and mouse which are optimized for use with your computer.

After installing the batteries the wireless keyboard and mouse are synced and ready to use. If you have a problem setting up your wireless keyboard and mouse, see “Wireless Keyboard or Mouse Problems” on page 24.

NOTE: The wireless keyboard and mouse have special features which may not be available on other devices that could be used with your computer.

Windows Vista® Setup

Your Dell computer is pre configured with Windows Vista. To set up Windows Vista for the first time, follow the instructions on the screen. These steps are mandatory and may take some time to complete. The screens will take you through several procedures including accepting license agreements, setting preferences, and setting up an Internet connection.

 **CAUTION: Do not interrupt the operating system's setup process. Doing so may render your computer unusable.**

Connect to the Internet (Optional)

 **NOTE:** ISPs and ISP offerings vary by country.

To connect to the Internet, you need an external modem or network connection and an Internet service provider (ISP). Your ISP will offer one or more of the following Internet connection options:

- DSL connections that provide high-speed Internet access through your existing telephone line or cellular telephone service. With a DSL connection, you can access the Internet and use your telephone on the same line simultaneously.
- Cable modem connections that provide high-speed Internet access through your local cable TV line.
- Satellite modem connections that provide high-speed Internet access through a satellite television system.

Setting Up Your Studio One

- Dial-up connections that provide Internet access through a telephone line. Dial-up connections are considerably slower than DSL and cable (or satellite) modem connections. Your computer does not have an integrated modem. An optional USB modem must be used for dial-up service with this computer.
- Wireless LAN connections that provide Internet access using WiFi 802.11 technology. Wireless LAN support requires optional internal components that may or may not be installed in your computer based on decisions made at the time of purchase.

 **NOTE:** If an external USB modem or WLAN adapter is not part of your original order you can purchase one from the Dell website at dell.com.

Setting Up a Wired Connection

- If you are using a dial-up connection, connect the telephone line to the external USB modem (optional) and to the telephone wall jack before you set up your Internet connection.
- If you are using a DSL or cable/satellite modem connection, contact your ISP or cellular telephone service for setup instructions.

To complete setting up your wired internet connection, follow the instructions in “Setting Up Your Internet Connection” on page 11.

Setting Up a Wireless Connection

 **NOTE:** To set up your wireless router, see the documentation that shipped with your router.

Before you can use your wireless Internet connection, you need to connect to your wireless router. To set up your connection to a wireless router:

1. Save and close any open files, and exit any open programs.
2. Click **Start**  → **Connect To**.
3. Follow the instructions on the screen to complete the setup.

Setting Up Your Internet Connection

If you do not have an ISP icon on your desktop or if you want to set up an Internet connection with a different ISP, perform the steps in the following section.

 **NOTE:** If you cannot connect to the Internet but have successfully connected in the past, the ISP might have a service outage. Contact your ISP to check the service status, or try connecting again later.

 **NOTE:** Have your ISP information ready. If you do not have an ISP, the **Connect to the Internet** wizard can help you get one.

1. Save and close any open files, and exit any open programs.

2. Click **Start**  → **Control Panel**.
3. Under **Network and Internet**, click **Connect to the Internet**.
The **Connect to the Internet** window appears.
4. Click either **Broadband (PPPoE)** or **Dial-up**, depending on how you want to connect:
 - Choose **Broadband** if you will use a DSL, satellite modem, cable TV modem, or Bluetooth® wireless technology connection.
 - Choose **Dial-up** if you will use an optional USB dial-up modem or ISDN.

 **NOTE:** If you do not know which type of connection to select, click **Help me choose** or contact your ISP.

Follow the instructions on the screen and use the setup information provided by your ISP to complete the setup.

Using Your Studio One

Front View Features

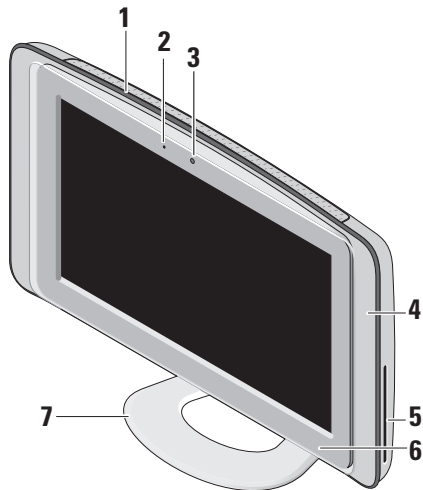

- 1 Air vents** — Internal fans create airflow through the vents to prevent the computer from overheating. The fans are turned on automatically when the computer gets hot. Fan noise is normal and does not indicate a problem with the fan or the computer.

⚠ WARNING: Ensure that none of the computer air vents are blocked. Blocking the vents will cause serious thermal problems.

- 2 Camera activity light (optional)** — Indicates if the camera is on or off.

3 Camera/microphone (optional) — Built-in camera and microphone array for video capture, conferencing, and chat.

4 Speakers (2)

5 Optical drive — Plays or records only standard-size (12 cm) CDs and DVDs. See “Using the Optical Disc Drive” on page 17 for more information.

6  Optical drive eject control — Lights up when the computer starts up and when a disc is in the optical drive. To eject a disc gently touch the control.

7 Computer stand — Use the stand to tilt the display to your preferred angle. It can be tilted up to 40°. The stand provides stability to the computer; it is not a removable part.

 **WARNING: The computer stand should remain installed at all times to ensure maximum system stability.**

 **NOTE:** Your computer Service Tag/Express Service Code is located on a label under the display glass. To view the Service Tag/Express Service Code tilt the display by 40°. Use this code when you access the Dell Support website or contact technical support.

Left Side Features

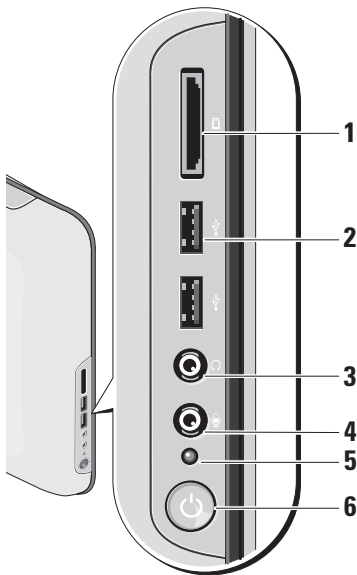



- 1  **Media Card Reader** — Provides a fast and convenient way to view and share digital photos, music, videos, and documents stored on the following digital memory cards:

- Secure digital (SD) memory card
- Multi Media Card (MMC)
- Memory Stick
- Memory Stick PRO
- xD-Picture Card (type - M and type - H)
- Hi Speed-SD
- Hi Density -SD

- 2  **USB 2.0 connectors (2)** — Connects to USB devices, such as a mouse, keyboard, printer, external drive, or MP3 player.

- 3  **Headphone or line-out connector** — Connects to headphones.

 **NOTE:** To connect to a powered speaker or sound system, use the **line out** connector on the back of your computer.

- 4  **Microphone or line-in connector** — Connects to a microphone for voice or to an audio cable for audio.

- 5 **Hard drive activity light** — Turns on when the computer reads or writes data. A flashing light indicates hard drive activity.

 **CAUTION:** To avoid loss of data, never turn off the computer while the hard drive activity light is flashing.

- 6  **Power button and light** — Turns the computer on or off when pressed. The light in the center of this button indicates the power state:

- Solid amber — the computer is in sleep state

OR

the system board cannot start initialization. There may be an issue with either the system board or the power supply.

- Solid white — the computer is in power-on state.
- Blinking amber — there is a power problem, a device may be malfunctioning or incorrectly installed.

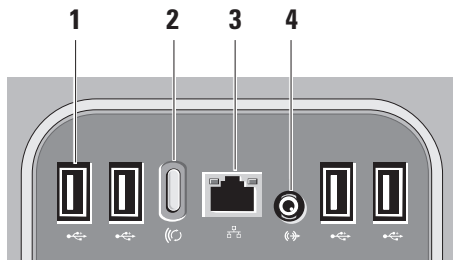

Back Panel Features



- 1**  **USB 2.0 connectors (4)** — Connects to USB devices, such as a mouse, keyboard, printer, external drive, or MP3 player.

- 2**  **Wireless sync button** — Reestablishes the connection between your computer, mouse, and keyboard. To use, press the sync button on the back of your computer, then on the device that you wish to reconnect.

 **NOTE:** The wireless sync button is functional only if you purchase a wireless keyboard and mouse along with your computer.

- 3**  **Network connector and light** — Connects your computer to a network or broadband device. The network activity light flashes when the computer is transmitting or receiving data. A high volume of network traffic may make this light appear to be in a steady “on” state.
- 4**  **Line-out connector** — Connects to a powered speaker or sound system.

Locating the Service Tag

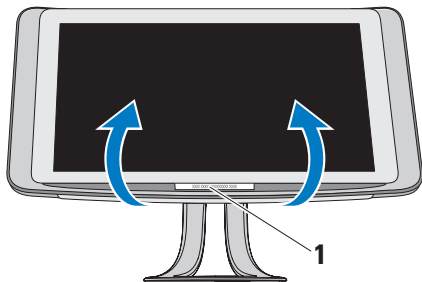

1 Service Tag

Gently tilt the display upwards to reveal the Service Tag.

Using the Optical Disc Drive

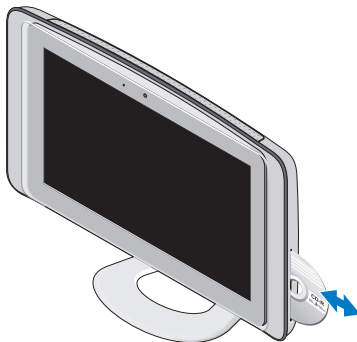

Insert the disc, with the label facing outwards and gently push the disc into the slot. The drive will automatically pull the disc in and begin reading its content. To eject a disc from the drive, gently touch the eject control.

Using the Touch Screen (Optional)

The touch screen feature on your Studio One converts your computer into an interactive display.

Dell Touch Zone

To launch the Dell Touch Zone software click **Start**  → **Dell Touch Zone**.

You can access the following features in the Dell Touch Zone software:

- **Picture Viewer** — View, organize, and edit pictures.
- **Dell Touch Cam** — Capture home videos with the built in web-cam. You can upload videos to **YouTube** when connected to the Internet.
- **Notes Creator** — Create typed or handwritten reminders. These notes will appear on the bulletin board the next time you access Dell Touch Zone.

- **Drum Zone** — Play a game to the music on your computer or play synthesized percussion instruments.
- **You Paint** — Draw, paint images, and edit photographs using this software.
- **Games** — Play select Windows games using touch.
- **Music** — Play music, create play lists, and browse through your music files by album, artist, or song title.
- **Internet Explorer** — Browse the Internet using multi-touch technology. Touch a link you want to follow or download.
- **Help** — Use the Help feature for more information on how to use the touch screen.

A video highlighting the features of the touch screen launches the first time your system starts up.



NOTE: To view the video at a later time, access it via Help or at **support.dell.com**.

Touch Screen Gestures

 **NOTE:** Some of these gestures may not work outside the Dell Touch Zone software.

Zoom

Allows you to increase or decrease the magnification of the screen content.

Pinch – Allows you to zoom in or zoom out by moving two fingers apart or bringing them closer together on the screen.



To zoom in: Move two fingers apart to enlarge the view of the active window.



To zoom out: Move two fingers close together to reduce the view of the active window.

Dwell

Allows you to access additional information by simulating a right-click.

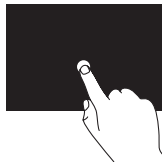

Press and hold a finger on the touch screen, to open context-sensitive menus.

Flick

Allows you to flip content forward or backward based on the direction of the flick.

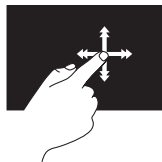

Move a finger quickly in the desired direction to flip through content in the active window like pages in a book. Flick also works vertically when navigating content such as images or songs in a playlist.

Scroll

Allows you to scroll through content. The scroll features include:

Pan – Allows you to move the focus on the selected object when the entire object is not visible.

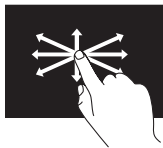

Move a finger in the desired direction to pan scroll the selected object.

Scroll Vertical – Allows you to scroll up or scroll down on the active window.

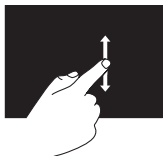

Move a finger up or down to activate vertical scrolling.

Scroll Horizontal – Allows you to scroll left or right on the active window.

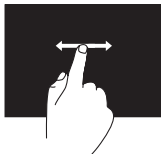

Move a finger to the left or right to activate scrolling horizontally.

Rotate

Allows you to rotate the active content on the screen.

Twist – Allows you to rotate active content in 90° increments using two fingers.





Keeping a finger or thumb in place, move the other finger in an arced direction right or left. You can also rotate the active content by moving both the fingers in a circular motion.

Software Features

 **NOTE:** For more information about the features described in this section, see the *Dell Technology Guide* available on your computer or on the Dell Support website at support.dell.com.

Facial Recognition (Optional)

Your computer may have the FastAccess facial recognition feature. This feature helps keep your Dell computer secure by learning the unique appearance of your face and uses this to verify your identity to automatically supply login information when you would normally enter this information yourself (such as for logging into a Windows account or into secure websites). For more information, click **Start**  → **Programs** → **FastAccess**.

 **NOTE:** This software feature is only available if you have the optional camera.

Productivity and Communication

You can use your computer to create presentations, brochures, greeting cards, fliers,

and spreadsheets. You can also edit and view digital photographs and images. Check your purchase order for software installed on your computer.

After connecting to the Internet, you can access websites, set up an e-mail account, upload and download files, and so on.

Entertainment and Multimedia

You can use your computer to watch videos, play games, create your own CDs, listen to music and radio stations. Your optical drive may support multiple disc media formats including CDs, DVDs, and Blu-ray Discs (if the option is selected at the time of purchase).

You can download or copy pictures and video files from portable devices, such as digital cameras and cell phones. Optional software applications enable you to organize and create music and video files that can be recorded to disc, saved on portable products such as MP3 players and handheld entertainment devices.

Customizing the Desktop

You can customize your desktop to change the appearance, resolution, wallpaper, screensaver, and so on by accessing the **Personalize appearance and sounds** window.

To customize your desktop:

1. Right-click an open area of the desktop.
2. Click **Personalize**, to open the **Personalize appearance and sounds** window and learn more about your customization options.

Customizing Energy Settings

You can change your energy settings by clicking **Start**  → **Control Panel** → **Power Options**.

Windows Vista® provides three default power options:

- **Balanced** — Delivers full performance when you need it and saves power during periods of inactivity.

- **Power saver** — Reduces system performance and the amount of energy consumed by your computer over its lifetime.
- **High performance** — Provides the highest level of system performance on your computer by adapting processor speed to your activity.

Backing Up Your Data

It is recommended that you periodically back up files and folders on your computer. To back up files:

1. Click **Start**  → **Control Panel** → **System and Maintenance** → **Welcome Center** → **Transfer files and settings**.
2. Click **Back up files** or **Back up computer**
3. Click **Continue** on the **User Account Control** window and follow the instructions in the Back up Files wizard.

Solving Problems

This section provides troubleshooting information for your computer. If you cannot solve your problem using the following guidelines, see “Using Support Tools” on page 30 or “Contacting Dell” on page 44.

Touch Screen Problems

Some or all multi-touch features are not working —

- Certain multi-touch features may be disabled. To enable multi-touch features, click the **Multi-touch settings** icon in the system tray.
- Certain touch screen features may be disabled. To enable the touch screen features, click **Start**  → **Control Panel** → **Pen and Input Devices**.
- The multi-touch feature may not be supported by the application.

If the touch screen starts losing its sensitivity —

The touch screen may have foreign particles (such as sticky notes) that are blocking the touch sensors. To remove these particles:

1. Turn off the computer.
2. Disconnect the power cord from the wall outlet.

 **CAUTION: Do not use water or a cleaning liquid to wipe the touch screen.**

3. Use a clean, lint-free cloth (can spray mild, non abrasive cleaner or water on cloth if needed, but not on screen) and wipe the surface and sides of the touch screen to remove any dirt or fingerprints.

Wireless Keyboard or Mouse Problems

If the mouse and keyboard stop communicating with the computer — The batteries may not be working or the keyboard and mouse have lost their connection with the computer.

- Check the batteries in the keyboard and mouse to ensure that they have enough power and are installed correctly.
- Re-establish a connection with the computer:
 - a. Press the wireless sync button at the back of your computer and then the wireless sync button on your keyboard.
 - b. Press the wireless sync button on the computer again, and then the wireless sync button on your mouse. The keyboard and mouse should now be paired.

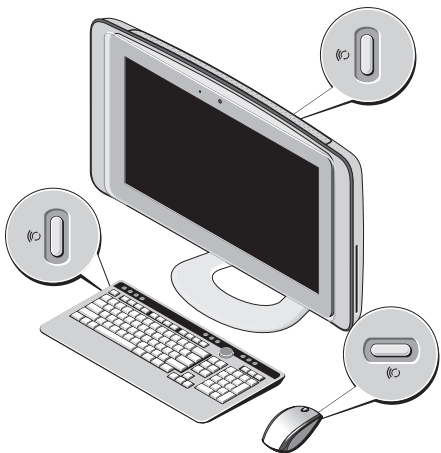

Network Problems

Wireless Connections

The network activity light on the integrated network connector lets you verify that your connection is working and provides information on the status:

- Yellow — A good connection exists between a wireless network and the computer.
- Off — The computer is not detecting a connection to the network.

If the network connection is lost — The wireless router is offline or wireless has been disabled on the computer.

Check your wireless router to ensure it is powered on and connected to your data source (cable modem or network hub). Re-establish your connection to the wireless router:

1. Save and close any open files, and exit any open programs.
2. Click **Start**  → **Connect To**.

3. Follow the instructions on the screen to complete the setup.

Wired Connections

The link integrity light on the integrated network connector lets you verify that your connection is working and provides information on the status:

- Green — A good connection exists between a 10/100 Mbps network and the computer.
- Off — The computer is not detecting a physical connection to the network.

If the network connection is lost — The cable is loose or damaged. Check the cable to ensure it is plugged in and not damaged.

Power Problems

If the power light is off — The computer is either turned off or is not receiving power.

- Reseat the power cable into both the power connector on the computer and the electrical outlet.
- If the computer is plugged into a power strip, ensure that the power strip is plugged into an electrical outlet and that the power strip is turned on. Also bypass power protection devices, power strips, and power extension cables to verify that the computer turns on properly.
- Ensure that the electrical outlet is working by testing it with another device, such as a lamp.
- Contact Dell (see “Contacting Dell” on page 44).

If the power light is white and the computer is not responding —

Contact Dell (see “Contacting Dell” on page 44).

If the power light is steady amber —

- The computer is in sleep state. Press a key on the keyboard, move the mouse, or press the power button to resume normal operation
- The system board cannot start initialization. There may be an issue with either the system board or power supply. For assistance, contact Dell (see “Contacting Dell” on page 44).

If the power light is blinking amber —

There is a power problem, a device may be malfunctioning or incorrectly installed. For assistance, contact Dell (see “Contacting Dell” on page 44).

If you encounter interference that hinders reception on your computer — An unwanted signal is creating interference by interrupting or

blocking other signals. Some possible causes of interference are:

- Power, keyboard, and mouse extension cables.
- Too many devices connected to a power strip.
- Multiple power strips connected to the same electrical outlet.

Memory Problems

If you receive an insufficient memory message —

- Save and close any open files and exit any open programs you are not using to see if that resolves the problem.
- See the software documentation for minimum memory requirements. For assistance, contact Dell (see “Contacting Dell” on page 44).
- Run Dell Diagnostics (see “Dell Diagnostics” on page 33).

If you experience other memory problems —

- Ensure that the memory you are using is supported by your computer. For more information about the type of memory supported by your computer, see “Specifications” on page 48.
- Run the Dell Diagnostics (see “Dell Diagnostics” on page 33).

Lockups and Software Problems

If the computer does not start up — Ensure that the power cable is firmly connected to the computer and to the electrical outlet.

A program stops responding —

End the program:

1. Press <Ctrl><Shift><Esc> simultaneously.
2. Click **Applications**.
3. Click the program that is no longer responding
4. Click **End Task**.

Solving Problems

If a program crashes repeatedly — Check the software documentation. If necessary, uninstall and then reinstall the program.

 **NOTE:** Software usually includes installation instructions in its documentation or on CD.

If the computer stops responding or a solid blue screen appears —

 **CAUTION:** You might lose data if you are unable to perform an operating system shutdown.

If you are unable to get a response by pressing a key on your keyboard or moving your mouse, press and hold the power button for at least 8 to 10 seconds until the computer turns off. Then restart your computer.

If a program is designed for an earlier Microsoft® Windows® operating system —

Run the Program Compatibility Wizard. The Program Compatibility Wizard configures a program so that it runs in an environment similar to non-Windows Vista operating system environments.

1. Click **Start**  → **Control Panel** → **Programs** → **Use an older program with this version of Windows**.
2. In the welcome screen, click **Next**.
3. Follow the instructions on the screen.

If you have other software problems —

- Back up your files immediately.
- Use a virus-scanning program to check the hard drive or CDs.
- Save and close any open files or programs and shut down your computer through the **Start**  menu.

- Check the software documentation or contact the software manufacturer for troubleshooting information:
 - Ensure that the program is compatible with the operating system installed on your computer.
 - Ensure that your computer meets the minimum hardware requirements needed to run the software. See the software documentation for information.
 - Ensure that the program is installed and configured properly.
 - Verify that the device drivers do not conflict with the program.
 - If necessary, uninstall and then reinstall the program.

Using Support Tools

Dell Support Center

The Dell Support Center helps you find the service, support, and system-specific information you need. For more information about Dell Support Center and available support tools, click the **Services** tab at support.dell.com.



Click the  icon in the taskbar to run the application. The home page provides links to access:

- Self Help (Troubleshooting, Security, System Performance, Network/Internet, Backup/Recovery, and Windows Vista®)
- Alerts (technical support alerts relevant to your computer)
- Assistance from Dell (Technical Support with DellConnect™, Customer Service, Training

and Tutorials, How-To Help with Dell on Call, and Online Scan with PCCheckUp)

- About Your System (System Documentation, Warranty Information, System Information, Upgrades & Accessories)

The top of the Dell Support Center home page displays your system's model number along with its service tag and express service code.

For more information about the Dell Support Center, see the *Dell Technology Guide* available on your computer or on the Dell Support website at support.dell.com.

Beep Codes

Your computer might emit a series of beeps during start-up if the monitor cannot display errors or problems. The following repetitive beep codes help you troubleshoot problems with your computer.

 **NOTE:** To replace parts see the *Service Manual* on the Dell Support website at support.dell.com.

One beep — *BIOS ROM checksum failure.
Possible motherboard failure*

Contact Dell (see “Contacting Dell” on page 44).

Two beeps — *No RAM Detected*

- Remove the memory modules, reinstall one module and restart the computer. If the computer starts normally, reinstall an additional module. Continue until you have identified a faulty module or reinstalled all modules without an error.
- If available, install memory modules of the same type in your computer.
- If the problem persists, contact Dell (see “Contacting Dell” on page 44).

Three beeps — *Possible motherboard failure*

Contact Dell (see “Contacting Dell” on page 44).

Four beeps — *RAM Read/Write failure*

- Ensure that no special memory module/memory connector placement requirements exist (see the *Service Manual* on the Dell Support website at support.dell.com).
- Verify that the memory modules you are installing are compatible with your computer.
- If the problem persists, contact Dell (see “Contacting Dell” on page 44).

Five beeps — *Real Time Clock Failure*

Replace the battery.

System Messages

If your computer has an issue or error, it may display a system message that will help you identify the cause and action needed to resolve the issue.

 **NOTE:** If the message you received is not listed in the following examples, see the documentation for either the operating system or the program that was running

Using Support Tools

when the message appeared. Alternatively you could see the *Service Manual* on the Dell Support website at support.dell.com or see “Contacting Dell” on page 44 for assistance.

Alert! Previous attempts at booting this system have failed at checkpoint [nnnn]. For help in resolving this problem, please note this checkpoint and contact Dell Technical Support —

The computer failed to complete the boot routine three consecutive times for the same error. See “Contacting Dell” on page 44 for assistance.

CMOS checksum error — Possible motherboard failure or RTC battery low. Replace the battery. See “Contacting Dell” on page 44 for assistance.

CPU fan failure — CPU fan has failed. See “Contacting Dell” on page 44 for assistance.

Hard-disk drive failure — Possible hard disk drive failure during HDD POST. See “Contacting Dell” on page 44 for assistance.

Hard-disk drive read failure — Possible hard disk drive failure during HDD boot test. See “Contacting Dell” on page 44 for assistance.

No timer tick interrupt — A chip on the system board might be malfunctioning or there may be a system board failure. See “Contacting Dell” on page 44 for assistance.

USB over current error — Disconnect the USB device. Your USB device needs more power for it to function properly. Use an external power source to connect the USB device, or if your device has two USB cables, connect both of them.

Hardware Troubleshooter

If a device is either not detected during the operating system setup or is detected but incorrectly configured, you can use the **Hardware Troubleshooter** to resolve the incompatibility.

To start the Hardware Troubleshooter:

1. Click **Start**  → **Help and Support**.

2. Type `hardware troubleshooter` in the search field and press <Enter> to start the search.
3. In the search results, select the option that best describes the problem and follow the remaining troubleshooting steps.

Dell Diagnostics

If you experience a problem with your computer, perform the checks in “Lockups and Software Problems” on page 27 and run the Dell Diagnostics before you contact Dell for technical assistance.

 **NOTE:** Dell Diagnostics works only on Dell computers.

 **NOTE:** The *Drivers and Utilities* media is optional and may not ship with your computer.

See the System Setup section in the *Service Manual* to review your computer’s configuration information, and ensure that the device that you want to test displays in the system setup program and is active.

Start the Dell Diagnostics from your hard drive or from the *Drivers and Utilities* media.

Starting Dell Diagnostics From Your Hard Drive

The Dell Diagnostics is located on a hidden diagnostic utility partition on your hard drive.

 **NOTE:** If your computer cannot display a screen image, see “Contacting Dell” on page 44.

1. Ensure that the computer is connected to an electrical outlet that is known to be working properly.
2. Turn on (or restart) your computer.

Using Support Tools

3. When the DELL™ logo appears, press <F12> immediately. Select **Diagnostics** from the boot menu and press <Enter>.

 **NOTE:** If you wait too long and the operating system logo appears, continue to wait until you see the Microsoft® Windows® desktop; then, shut down your computer and try again.

 **NOTE:** If you see a message stating that no diagnostics utility partition has been found, run the Dell Diagnostics from the *Drivers and Utilities* media.

4. Press any key to start the Dell Diagnostics from the diagnostics utility partition on your hard drive.

Starting Dell Diagnostics From the Drivers and Utilities Media

1. Insert the *Drivers and Utilities* media.
2. Shut down and restart the computer.
When the DELL logo appears, press <F12> immediately.

 **NOTE:** If you wait too long and the operating system logo appears, continue to wait until you see the Microsoft® Windows® desktop; then, shut down your computer and try again.

 **NOTE:** The next steps change the boot sequence for one time only. On the next start-up, the computer boots according to the devices specified in the system setup program.

3. When the boot device list appears, highlight **CD/DVD/CD-RW** and press <Enter>.
4. Select the **Boot from CD-ROM** option from the menu that appears and press <Enter>.
5. Type 1 to start the CD menu and press <Enter> to proceed.
6. Select **Run the 32 Bit Dell Diagnostics** from the numbered list. If multiple versions are listed, select the version appropriate for your computer.
7. When the Dell Diagnostics **Main Menu** appears, select the test you want to run.

System Recovery Options

You can restore your operating system in the following ways:

- System Restore returns your computer to an earlier operating state without affecting data files. Use System Restore as the first solution for restoring your operating system and preserving data files.
- Dell Factory Image Restore returns your hard drive to the operating state it was in when you purchased the computer. Dell Factory Image Restore procedures permanently delete all data on the hard drive and remove any programs installed after you received the computer. Use Dell Factory Image Restore only if System Restore did not resolve your operating system problem.
- If you received an Operating System media with your computer, you can use it to restore your operating system. However, using the

Operating System media also deletes all data on the hard drive. Use the disc only if neither System Restore nor Dell Factory Image Restore did not resolve your operating system problem.

System Restore

The Windows operating systems provide a System Restore option which allows you to return your computer to an earlier operating state (without affecting data files) if changes to the hardware, software, or other system settings have left the computer in an undesirable operating state. Any changes that System Restore makes to your computer are completely reversible.

 **CAUTION: Make regular backups of your data files. System Restore does not monitor your data files or recover them.**

System Recovery Options

 **NOTE:** The procedures in this document were written for the Windows default view, so they may not apply if you set your Dell™ computer to the Windows Classic view.

Starting System Restore

1. Click **Start** .
2. In the **Start Search** box, type `System Restore` and press <Enter>.

 **NOTE:** The **User Account Control** window may appear. If you are an administrator on the computer, click **Continue**; otherwise, contact your administrator to continue the desired action.

3. Click **Next** and follow the remaining prompts on the screen.

In the event that System Restore did not resolve the issue, you may undo the last system restore.

Undoing the Last System Restore

 **NOTE:** Before you undo the last system restore, save and close all open files and exit any open programs. Do not alter, open,

or delete any files or programs until the system restoration is complete.

1. Click **Start** .
2. In the **Start Search** box, type `System Restore` and press <Enter>.
3. Click **Undo my last restoration** and click **Next**.

Dell Factory Image Restore

 **CAUTION:** Using Dell Factory Image Restore permanently deletes all data on the hard drive and removes any programs or drivers installed after you received your computer. If possible, back up the data before using these options. Use Dell Factory Image Restore only if System Restore did not resolve your operating system problem.

 **NOTE:** Dell Factory Image Restore may not be available in certain countries or on certain computers.

This option restores your hard drive to the operating state it was in when you purchased the computer. Any programs or files added since you received your computer—including data files—are permanently deleted from the hard drive. Data files include documents, spreadsheets, e-mail messages, digital photos, music files, and so on. If possible, back up all data before using Factory Image Restore.

Dell Factory Image Restore

1. Turn on the computer. When the Dell logo appears, press <F8> several times to access the **Vista Advanced Boot Options** Window.

 **NOTE:** If the operating system logo appears, wait until you see the Microsoft® Windows® desktop; then, shut down your computer and try again.

2. Select **Repair Your Computer**.
3. The **System Recovery Options** window appears.
4. Select a keyboard layout and click **Next**.

5. To access the recovery options, log on as a local user. To access the command prompt, type `administrator` in the **User name** field, then click **OK**.

6. Click **Dell Factory Image Restore**. The **Dell Factory Image Restore** welcome screen appears.

 **NOTE:** Depending upon your configuration, you may need to select **Dell Factory Tools**, then **Dell Factory Image Restore**.

7. Click **Next**. The **Confirm Data Deletion** screen appears.

 **CAUTION:** If you do not want to proceed with **Factory Image Restore**, click **Cancel**.

8. Select the check box to confirm that you want to continue reformatting the hard drive and restoring the system software to the factory condition, then click **Next**.

The restore process begins and may take five or more minutes to complete. A message appears when the operating system and

System Recovery Options

factory-installed applications have been restored to factory condition.

9. Click **Finish** to reboot the system.

Operating System Reinstallation Before You Begin

If you are considering reinstalling the Windows operating system to correct a problem with a newly installed driver, first try using Windows Device Driver Rollback. If Device Driver Rollback does not resolve the problem, then use System Restore to return your operating system to the operating state it was in before you installed the new device driver. See “System Restore” on page 35.

 **CAUTION:** Before performing the installation, back up all data files on your hard drive. For conventional hard drive configurations, the hard drive is the first drive detected by the computer.

Use Operating System Reinstallation media only as the last method to restore your operating system.

To reinstall Windows, you need the following items:

- *Operating System* media
- *Dell Drivers and Utilities* media

 **NOTE:** The *Dell Drivers and Utilities* media contains drivers that were installed during the assembly of the computer. Use the *Dell Drivers and Utilities* media to load any required drivers. Depending on the region from which you ordered your computer, or whether you requested the media, the *Dell Drivers and Utilities* media and *Operating System* media may not ship with your computer. Alternatively, you can also use the Dell Factory Image Restore as it contains all the drivers that are available on your computer.

Reinstalling Windows Vista

The reinstallation process can take 1 to 4 hours to complete. After you reinstall the operating system, you must also reinstall the device drivers, virus protection program, and other software.

1. Save and close any open files and exit any open programs.
2. Insert the *Operating System* media.
3. Click **Exit** if the **Install Windows** message appears.
4. Restart the computer.
5. When the DELL logo appears, press <F12> immediately.

 **NOTE:** If the operating system logo appears, continue to wait until you see the Microsoft® Windows® desktop; then, shut down your computer and try again.

 **NOTE:** The next steps change the boot sequence for one time only. On the next start-up, the computer boots according to the devices specified in the system setup program.

6. When the boot device list appears, highlight **CD/DVD/CD-RW Drive** and press <Enter>.
7. Press any key to **Boot from CD-ROM**. Follow the instructions on the screen to complete the installation.

Getting Help

If you experience a problem with your computer, you can complete the following steps to diagnose and troubleshoot the problem:

1. See “Solving Problems” on page 23 for information and procedures that pertain to the problem your computer is experiencing.
2. See “Dell Diagnostics” on page 33 for procedures on how to run Dell Diagnostics.
3. Fill out the “Diagnostic Checklist” on page 44.
4. Use Dell’s extensive suite of online services available at Dell Support (support.dell.com) for help with installation and troubleshooting procedures. See “Online Services” on page 41 for a more extensive list of Dell Support online.
5. If the preceding steps have not resolved the problem, see “Contacting Dell” on page 44.

 **NOTE:** Call Dell Support from a telephone near or at the computer so that the support staff can assist you with any necessary procedures.

 **NOTE:** Dell’s Express Service Code system may not be available in all countries.

When prompted by Dell’s automated telephone system, enter your Express Service Code to route the call directly to the proper support personnel. If you do not have an Express Service Code, open the **Dell Accessories** folder, double-click the **Express Service Code** icon, and follow the directions.

 **NOTE:** Some of the following services are not always available in all locations outside the continental U.S. Call your local Dell representative for information on availability.

Technical Support and Customer Service

Dell's support service is available to answer your questions about Dell hardware. Our support staff uses computer-based diagnostics to provide fast, accurate answers.

To contact Dell's support service, see "Before You Call" on page 43 and then see the contact information for your region or go to **support.dell.com**.

DellConnect

DellConnect is a simple online access tool that allows a Dell service and support associate to access your computer through a broadband connection, diagnose your problem and repair it all under your supervision. For more information, go to **support.dell.com** and click **DellConnect**.

Online Services

You can learn about Dell products and services on the following websites:

- **www.dell.com**
- **www.dell.com/ap** (Asian/Pacific countries only)
- **www.dell.com/jp** (Japan only)
- **www.euro.dell.com** (Europe only)
- **www.dell.com/la** (Latin American and Caribbean countries)
- **www.dell.ca** (Canada only)

You can access Dell Support through the following websites and e-mail addresses:

Dell Support websites

- **support.dell.com**
- **support.jp.dell.com** (Japan only)
- **support.euro.dell.com** (Europe only)

Getting Help

Dell Support e-mail addresses

- **mobile_support@us.dell.com**
- **support@us.dell.com**
- **la-techsupport@dell.com** (Latin America and Caribbean countries only)
- **apsupport@dell.com** (Asian/Pacific countries only)

Dell Marketing and Sales e-mail addresses

- **apmarketing@dell.com** (Asian/Pacific countries only)
- **sales_canada@dell.com** (Canada only)

Anonymous file transfer protocol (FTP)

- **ftp.dell.com**

Log in as user: `anonymous`, and use your e-mail address as your password.

Automated Order-Status Service

To check on the status of an order or if you have a problem with your order, such as missing part, wrong parts, or incorrect billing, contact

Dell (see “Contacting Dell” on page 44 or go to **support.dell.com**).



NOTE: Have your invoice or packing slip handy when you call.

Product Information

If you need information about additional products available from Dell, or if you would like to place an order, visit the Dell website at **www.dell.com**. For the telephone number to call for your region or to speak to a sales specialist, see “Contacting Dell” on page 44.

Returning Items for Repair Under Warranty or for Credit

Prepare all items being returned, whether for repair or credit, as follows:

1. Call Dell to obtain a Return Material Authorization Number, and write it clearly and prominently on the outside of the box.

- ✎ **NOTE:** For the telephone number to call for your region, see “Contacting Dell” on page 44.
- 2. Include a copy of the invoice and a letter describing the reason for the return.
- 3. Include a copy of the Diagnostics Checklist (see “Diagnostic Checklist” on page 44), indicating the tests that you have run and any error messages reported by the Dell Diagnostics (see “Dell Diagnostics” on page 33).
- 4. Include any accessories that belong with the item(s) being returned (power cables, software, guides, and so on) if the return is for credit.
- 5. Pack the equipment to be returned in the original (or equivalent) packing materials.
- ✎ **NOTE:** You are responsible for paying shipping expenses. You are also responsible for insuring any product returned, and you assume the risk of loss during shipment to Dell. Collect On Delivery (C.O.D.) packages are not accepted.

- ✎ **NOTE:** Returns that are missing any of the preceding requirements will be refused at Dell’s receiving dock and returned to you.

Before You Call

- ✎ **NOTE:** Have your Express Service Code ready when you call. The code helps Dell’s automated-support telephone system direct your call more efficiently. You may also be asked for your Service Tag (located on a label under the display glass. To view the Service Tag tilt the display by 40°).

Remember to fill out the following Diagnostic Checklist. If possible, turn on your computer before you call Dell for assistance and call from a telephone at or near the computer. You may be asked to type some commands at the keyboard, relay detailed information during operations, or try other troubleshooting steps possible only at the computer itself. Ensure that the computer documentation is available.

Diagnostic Checklist

- Name:
- Date:
- Address:
- Phone number:
- Service Tag/ Express Service Code (located on a label under the display glass. To view the Service Tag tilt the display by 40°):
- Return Material Authorization Number (if provided by Dell support technician):
- Operating system and version:
- Devices:
- Expansion cards:
- Are you connected to a network? Yes /No
- Network, version, and network adapter:
- Programs and versions:

See your operating system documentation to determine the contents of the computer's start-up files. If the computer is connected to

a printer, print each file. Otherwise, record the contents of each file before calling Dell.

- Error message, beep code, or diagnostic code:
- Description of problem and troubleshooting procedures you performed:

Contacting Dell

For customers in the United States, call 800-WWW-DELL (800-999-3355).



NOTE: If you do not have an active Internet connection, you can find contact information on your purchase invoice, packing slip, bill, or Dell product catalog.

Dell provides several online and telephone-based support and service options. Availability varies by country and product, and some services may not be available in your area.

To contact Dell for sales, technical support, or customer service issues:

1. Visit **support.dell.com**.
2. Verify your country or region in the **Choose A Country/Region** drop-down menu at the bottom of the page.
3. Click **Contact Us** on the left side of the page.
4. Select the appropriate service or support link based on your need.
5. Choose the method of contacting Dell that is convenient for you.

 **NOTE:** For technical support fill out the Diagnostic Checklist (see “Diagnostic Checklist” on page 44) before you call Dell.

Finding More Information and Resources

If you need to:

reinstall your operating system.

run a diagnostic program for your computer, reinstall desktop system software, or update drivers for your computer, and readme files.

learn more about your operating system, maintaining peripherals, RAID, Internet, Bluetooth®, networking, and e-mail.

upgrade your computer with new or additional memory, or a new hard drive.

reinstall or replace a worn or defective part.

See:

your operating system disc.

the *Drivers and Utilities* disc.



NOTE: Drivers and documentation updates can be found on the Dell™ Support website at **support.dell.com**.

the *Dell Technology Guide* available on your computer or on the Dell Support website at **support.dell.com**.

the *Service Manual* on the Dell Support website at **support.dell.com**.



NOTE: In some countries, opening and replacing parts of your computer may void your warranty. Check your warranty and return policies before working inside your computer.

If you need to:

find safety best practices information for your computer, review Warranty information, Terms and Conditions (U.S. only), Safety instructions, Regulatory information, Ergonomics information, and End User License Agreement.

find your Service Tag/Express Service Code— You must use the Service Tag to identify your computer on **support.dell.com** or to contact technical support.

find drivers and downloads.
access technical support and product help.
check on your order status for new purchases.
find solutions and answers to common questions.
locate information for last-minute updates about technical changes to your computer or advanced technical-reference material for technicians or experienced users.

See:

the safety and regulatory documents that shipped with your computer and also see the Regulatory Compliance Homepage at **www.dell.com/regulatory_compliance**.

under the display glass. To view the Service Tag tilt the display by 40°.

the Dell™ Support website at **support.dell.com**.

Specifications

System model

Studio One 1909

This section provides information that you may need when setting up, updating drivers for, and upgrading your computer.



NOTE: Offerings may vary by region.

For more information regarding the configuration of your computer, click

Start  → **Help and Support** and select the option to view information about your computer.

Processor

Intel® Core™2 Duo

Intel Core2 Quad

Intel Celeron®

Intel Celeron Dual-Core

Drives and devices

Drives	One 3.5-inch internal hard-drive, one slim-line slot-load optical drive
Wireless (optional)	LAN, 802.11b/g, 802.11 a/b/g/n Internal RF
Camera (optional)	1.3 mega pixel

Drives and devices

Available devices	Serial ATA hard drive, DVD and CD-RW combo drive (optional), DVD+/- RW (optional), Blu-ray Disc™ (optional), microphone array, and 7-in-1 Media Card Reader.
-------------------	--

Memory

Type	Dual channel 800 MHz DDR2
Connectors	Two
Capacities	512 MB, 1 GB, and 2 GB
Minimum	1 GB
Maximum	4 GB

Computer information

System chipset	nVIDIA MCP7A
Data bus width	64 bits
Address bus width	32 bits
BIOS chip (NVRAM)	8 Mb
Memory speed	800 MHz
System bus frequency	1333-MHz data rate (depending on your processor)

External connectors

Network adapter	RJ45 connector
USB 2.0	Two side-panel and four back-panel connectors

Specifications

External connectors

Audio	Two side-panel connectors for microphone/line-in and headphone/line-out; one back-panel connector for line-out
-------	---

Audio

Type	Integrated speakers
Power	4W x 2
Frequency response	150 Hz to 15 kHz

Video

Type	nVIDIA MCP7A
LCD interface	LVDS

Display

Type (active-matrix TFT)	18.5 inches, 16:9, WXGA
Maximum resolution	1366 x 768
Luminance	300 cd/m ²
Response time (typical)	5.0 ms
Contrast ratio	1000:1
Tilt	0° to + 40°
Viewing angles	Horizontal +/- 85° Vertical +/- 80°

Physical

Approximate height (with stand)	39.7 cm (15.6 inches)
Approximate width	56.1 cm (22.08 inches)

Physical

Approximate depth (without cables or stand)	8.21 cm (3.23 inches)
Approximate depth with touch screen (without cables or stand)	8.85 cm (3.48 inches)
Approximate depth (with stand installed)	19.25 cm (7.57 inches)
Approximate weight (with stand)	10.4 kg (22.92 lb)
Approximate weight with touch screen (with stand)	10.3 kg (22.70 lb)

Power

Wattage	190 W
Voltage	100-240 VAC
Backup battery	3-V CR2032 lithium coin cell

Computer environment*Temperature:*

Operating	10c to 35° C (50° to 95° F)
Storage	-40° to 65° C (-40° to 149° F)
Relative humidity	20% to 80% (noncondensing)

Specifications

Computer environment

Maximum Vibration:

Operating	0.26 Grms random for 2 min in all operational orientations
Storage	2.2 Grms random for 15 mins

Maximum Shock:

Operating	Half-Sine Pulse: 40G for 2ms with a change in velocity of 20 in/s (51 cm/s)
Storage	Half-Sine Pulse: 40G for 22 ms with a change in velocity of 240 in/s (609 cm/s)

Computer environment

Altitude:

Operating	-15.2 to 3048 m (-50 to 10,000 ft)
Storage	-15.2 to 10,668 m (-50 to 35,000 ft)
Airborne containment level	G2 or lower as defined by ISA-S71.04-1985

Appendix

The information in this document also applies to the products listed below:

- Dell™ Studio One 1909
- Dell™ Studio One 19

Macrovision Product Notice

This product incorporates copyright protection technology that is protected by method claims of certain U.S. patents and other intellectual property rights owned by Macrovision Corporation and other rights owners. Use of this copyright protection technology must be authorized by Macrovision Corporation, and is intended for home and other limited viewing uses only unless otherwise authorized by Macrovision Corporation. Reverse engineering or disassembly is prohibited.

Index

A

- airflow, allowing **5**
- audio **50**

B

- backups
 - creating **22**

C

- calling Dell **43**
- CDs, playing and creating **21**
- chipset **49**
- computer
 - weights and dimensions **50**
- computer capabilities **21**
- computer environment **51**
- computer information **49**

- computer, setting up **5**
- connect(ing)
 - optional network cable **6**
 - using dial-up **10**
 - via DSL **10**
 - via WLAN **10**
 - wireless keyboard **7**
- connectors
 - back view **14**
- contacting Dell online **44**
- customer service **41**
- customizing
 - your desktop **21**

D

- DellConnect **41**
- Dell Diagnostics **33**
- Dell Factory Image Restore **35**
- Dell Support Center **30**
- Dell support website **47**
- Dell Technology Guide
 - for further information **46**
- Dell Touch Zone **18**
- drivers and downloads **47**
- drives and devices **48**
- DVDs, playing and creating **21**

E

- email addresses
 - for technical support **42**
- energy
 - conserving **22**

- expansion bus **50**

F

- finding more information **46**
- flick **19**
- front-side connectors **12**
- FTP login, anonymous **42**

G

- gestures **19**

H

- hard drive activity light **15**
- hardware problems
 - diagnosing **33**
- Hardware Troubleshooter **32**
- headphone
 - front connector **15**

Index

help

getting assistance and support **40**

I

Internet connection **9**

ISP

Internet Service Provider **9**

L

line-in connector **15**

M

media card reader **14**

memory

minimum and maximum **49**

memory problems

solving **27**

Memory Stick reader **14**

memory support **49**

microphone connector **15**

MMC **14**

Multi Media Card reader **14**

N

network connection

fixing **25**

network connector

location **16**

network speed

testing **25**

P

physical specifications **50**

ports and connectors **49**

power button and light **15**

power problems, solving **26**

power specifications **51**

problems, solving **23**

processor **48**

products

information and purchasing **42**

R

reinstalling Windows **35**

resources, finding more **46**

restoring factory image **36**

S

SD card reader **14**

setup, before you begin **5**

shipping products

for return or repair **42**

software features **21**

software problems **27**

solving problems **23**

specifications **48**

support email addresses **42**

support sites

worldwide **41**

system messages **31**

system reinstall options **35**

System Restore **35**

T

technical support **41**

touch screen **18**

touch screen gestures

gestures

multi-touch gestures **19**

U

USB 2.0

back connectors **14, 16**

V

ventilation, ensuring **5**

W

warranty returns **42**

Windows, reinstalling **35**

Windows Vista®

 Program Compatibility Wizard **28**

 reinstalling **39**

wireless mouse and keyboard

 reconnecting **24**

wireless network connection **25**

wireless sync button **16**

X

xD-Picture Card reader **14**



Printed in the U.S.A.

www.dell.com | support.dell.com



0P687XA01